

SLC Single-line compact metering device for grease

Offers leading technology in single-line lubrication



Reliable metering with single-line flexibility

The Lincoln SLC metering device is designed for use in high-pressure single-line lubrication systems and features a modular design. Also, delivery volume can be adjusted via metering screws to ensure each lubrication point receives the required amount of lubricant.

Advantages:

- High venting capability
- Wide delivery volume range
- Compact construction
- Easy to monitor and maintain
- Simplified failure analysis
- Reduced risk of leaks
- Reliable operation in harsh conditions with a wide operating temperature range
- Patented design and functionality
- Easy to clean

Features:

- Customized design options:
 - BSP or NPTF threads
 - Metric and imperial sizes for inlet and outlet fittings
 - Fixed metering or variable adjustment screws to set the required outlet quantity
 - Various monitoring options
 - Available as customized kit with flexible hoses
- No rubber seals
- Steel housing with precisely mated pistons

High venting capability

Featuring a spring-reset control piston, the metering device has a high venting capability compatible with greases up to NLGI 2. The SLC offers reliable metering even with unstable greases which tend to bleed. This helps increase the life span of the pump and creates less stress on all parts of the lubrication system.

Wide range of applications

With the most compact construction in its class, the SLC is suitable for renewable energy, construction and mining applications including heavy industry.

The overall sturdy design allows for economical replacement of small and medium sized dual-line systems.

Designed for your needs

The SLC offers easy configuration to meet your needs, including different output quantity, fitting and adjustment options. In addition, the SLC enables quick and cost-effective integration of visual or electrical performance indicators.

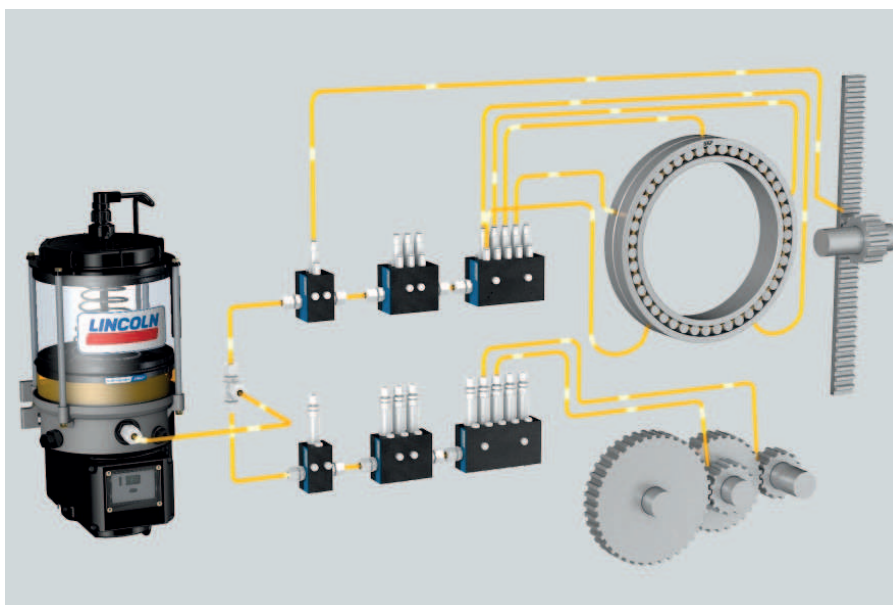

Possible system layout including a pump

Advantages of a single-line system:

- Simple system layout
- Provides exact metering
- Offers increased flexibility
- Greases that tend to bleed can be delivered more reliably
- If one lubrication point fails, the system continues to operate

SLC provides numerous advantages

Modular, seal-less design

The SLC is available in two versions – the SLC1 with a metering volume range from 0.1 to 0.7 cm³ (0.006–0.042 in³) per outlet and lubrication cycle. The SLC2 comes with a metering volume of 0.2 to 1.4 cm³ (0.012–0.084 in³). Both are offered with BSP thread for metric tubing or NPTF threads for imperial tubing .

Additional parts, such as metering screws to set the required outlet quantity or performance indicators, can be easily placed on top or bottom of the device in the optimum assembly position and visual range. The SLC metering device has no rubber seals for durability and long life. Its block design means less jointing and reduced risk of leaks.

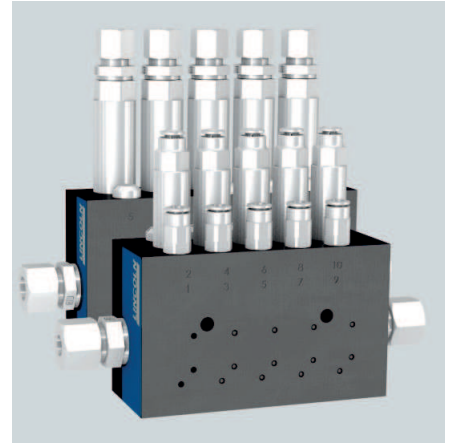

Easy monitoring

The SLC metering device is compatible for use with a screw-in piston detector to monitor proper function of two outlets on the SLC1 and of one outlet on the SLC2.

Easy functionality test can be run using the visual memory indicators. These show reliably correct functionality after only one test lubrication cycle and keep a detected section failure visible permanently.

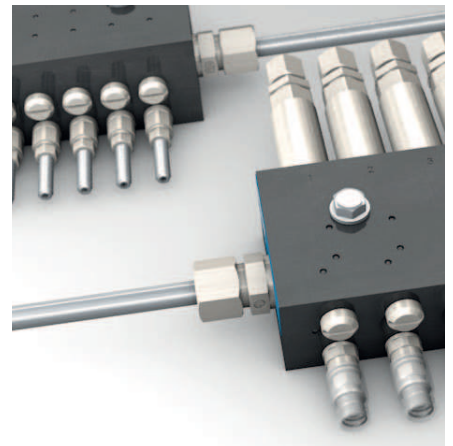

Operation in low temperatures

The patented technology of the SLC devices allows efficient and trouble-free functionality also at low operating temperatures or in extended lubrication systems.

SKF has a global network of application engineering supporting you to design the lubrication system right to your application requirements.



Metering and monitoring options

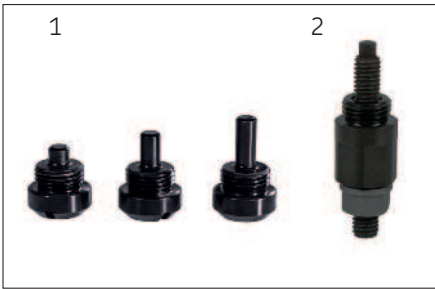

Output adjustment

1 Metering screws

- Provide a pre-set metering volume per stroke

2 Adjusting screws

- Provide adjustable metering volumes

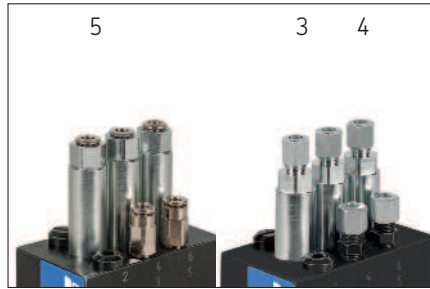

Outlet fitting options

3 Standard cutting ring technology

4 Advanced leakage-free and vibration proof E02 fittings for demanding applications

5 Plug-in quick connectors for quick assembly

6 Internal cross porting (only SLC1)

- Special closure plug instead of an outlet adapter
- Doubles the output volume or enables uneven outlet numbers (single outlet instead of twin)

7 Outlet extension (only SLC1)



Monitoring options

8 Visual memory indicator

- Trouble free, magnetic type design
- Easy to use
- Stainless steel, corrosion class C5-M
- Red colored ring indicates malfunction and has a plastic protecting cap.
- Mounting position at bottom (for opposite lubricant outlets)

9 Electric performance indicator

- Universal low-voltage piston detector
- Stainless steel, corrosion class C5-M
- A built-in LED makes the SLC working stroke visible.
- Plug connection M12x1 - 4 pole.

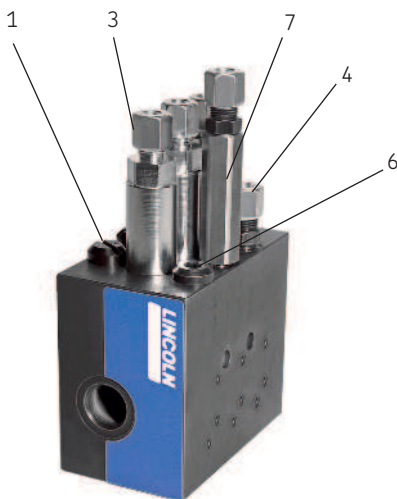

Possible layout variants

The SLC metering device offers various options to adjust the output volume. The SLC1 can be turned upside down to easily access the outlet extensions.

Additional parts, such as electric performance indicators or metering screws, can be placed on top or bottom of the device in the optimum visual range and easy service. The visual performance indicator can be placed only on bottom of the device.

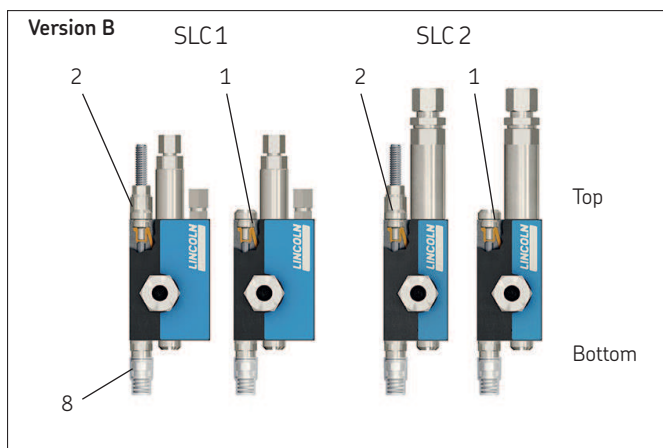
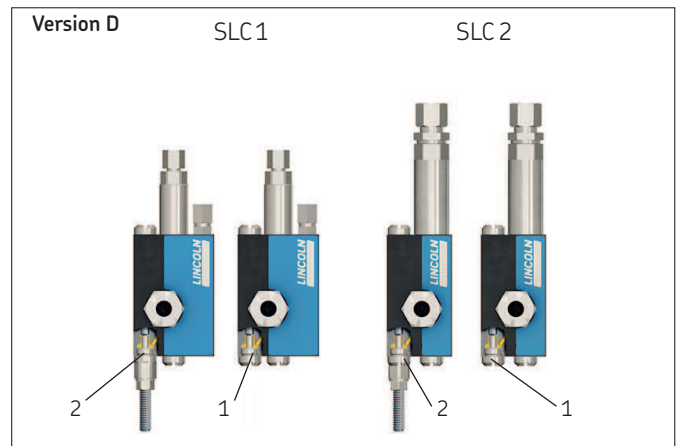
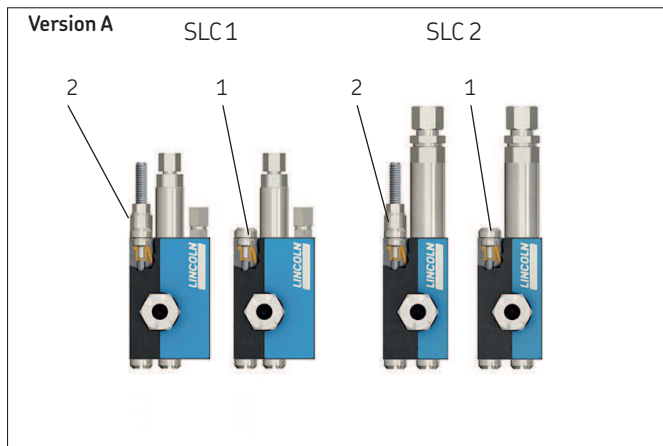
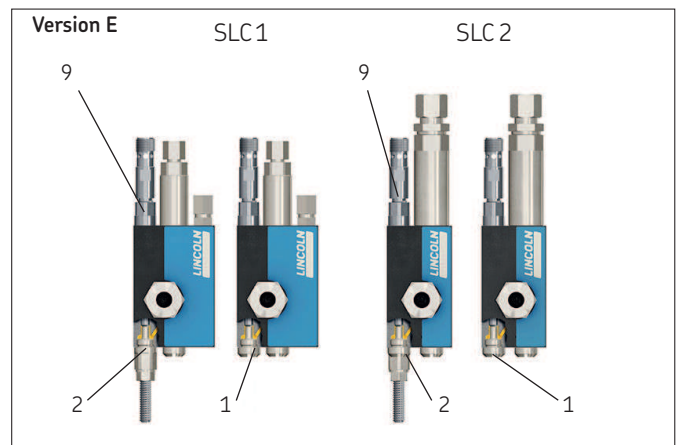
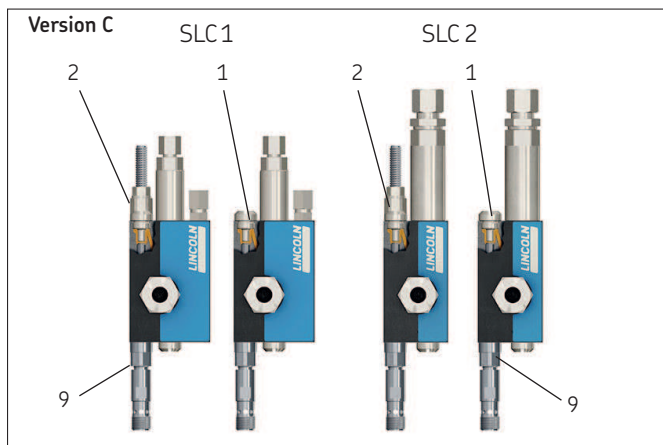

Table 1

Layout variants					
Top	Stroke adjustment (1; 2)	•	•	•	
	Electrical performance indicator (9)				•
Version / Order code					
		A	B	C	D
Bottom	Stroke adjustment (1; 2)				•
	Visual memory indicator (8)		•		
	Electrical performance indicator (9)			•	

1 Metering screw
2 Adjustment screw
8 Visual memory indicator
9 Electrical performance indicator



SLC1 and SLC2 in comparison

SLC1



- Stroke volume per outlet:
0,1–0,7 cm³ (0.006–0.042 in³)
- 1–12 outlets (2 outlets per pair of pistons)
- Internal cross porting of two outlets to double the output possible
- Outlet extensions available
- Integrated outlet connectors
- Compact design for applications with limited space

SLC2



- Stroke volume per outlet:
0,2–1,4 cm³ (0.012–0.084 in³)
- 1–6 outlets (1 outlet per pair of pistons)
- Robust outlet connection G1/4 or 1/4 NPTF
- Reliable for heavy industry applications
- Wide outlet spacing allows for large sized fittings and feed line dimensions

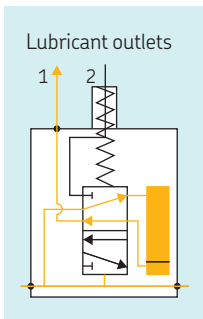

Hydraulic schematic SLC1

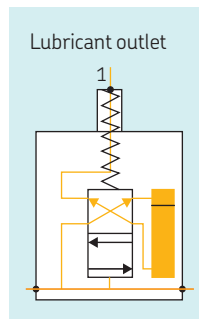

Hydraulic schematic SLC2

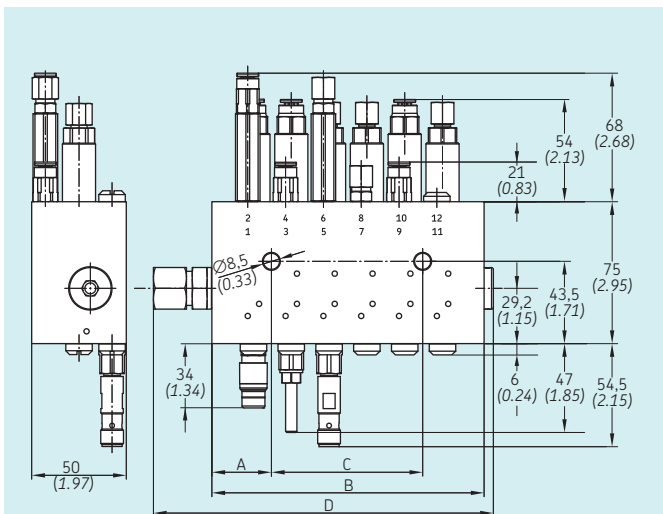

	SLC1-2		SLC1-4		SLC1-6		SLC1-8		SLC1-10		SLC1-12	
	mm	in.	mm	in.	mm	in.	mm	in.	mm	in.	mm	in.
A	11,5	0.45	31,5	1.24	31,5	1.24	31,5	1.24	31,5	1.24	31,5	1.24
B	44	1.73	64	2.52	84	3.31	104	4.09	124	4.88	144	5.67
C	20	0.78	20	0.78	20	0.78	40	1.57	60	2.36	80	3.15
D	79,8	3.14	99,8	3.93	119,8	4.71	139,8	5.50	159,8	6.29	179,8	7.08

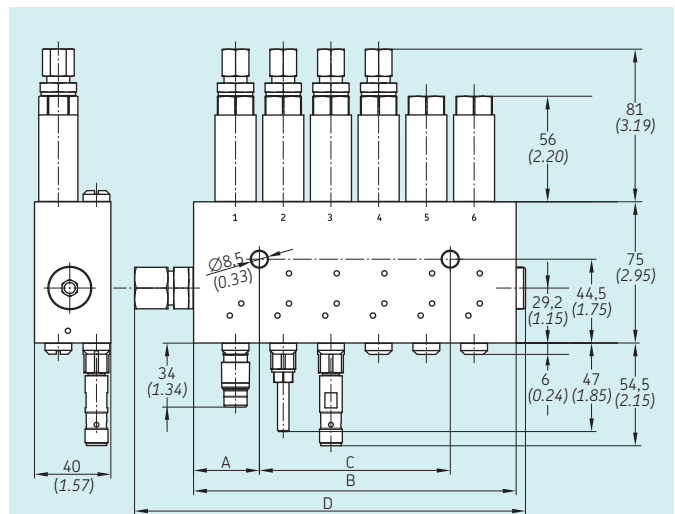

	SLC2-1		SLC2-2		SLC2-3		SLC2-4		SLC2-5		SLC2-6	
	mm	in.	mm	in.	mm	in.	mm	in.	mm	in.	mm	in.
A	9,5	0.37	34,5	1.36	34,5	1.36	34,5	1.36	34,5	1.36	34,5	1.36
B	44	1.73	69	2.72	94	3.7	119	4.69	144	5.67	169	6.65
C	25	0.98	25	0.98	25	0.98	50	1.97	75	2.95	100	3.94
D	79,8	3.14	104,8	4.13	129,8	5.11	154,8	6.09	179,8	7.08	204,8	8.06

Technical data and features

Table 2

Basic metering device				
Similar features	SLC1 and SLC2			
Lubricant	Grease up to NLGI 2			
Function principle	Single-line metering device with spring loaded control pistons and double acting delivery pistons			
System pressure	150–315 bar	2 175–4 570 psi		
Max. relief or venting pressure	68 bar	990 psi		
Operating temperature	–40 to +100 °C	–40 to +212 °F		
Lubricant inlet connection	G ^{3/8} or ^{3/8} NPTF			
Lubricant inlet fittings for tube outer diameter	8, 10, 12 mm or 1/4, 3/8, 1/2			
Material	Steel			
Corrosion protection class (DIN EN ISO 12944)	C3-High, C4-Medium			
Mounting position	any, preferable vertical			
Varying features	SLC1	SLC2		
Number of lubricant outlets	1–12	1–6		
Delivery volume per outlet and stroke* Pre-set	0,1; 0,15; 0,2; 0,25; 0,3; 0,4; 0,5; 0,6; 0,7 cm ³	0.0061; 0.0091; 0.012; 0.015; 0.018; 0.024; 0.03; 0.036; 0.042 in ³	0,2; 0,3; 0,4; 0,5; 0,6; 0,8; 1,0; 1,2; 1,4 cm ³	0.012; 0.018; 0.024; 0.03; 0.036; 0.049; 0.06; 0.073; 0.084 in ³
Adjustable	0,1–0,7 cm ³	0.006–0.042 in ³	0,2–1,4 cm ³	0.012–0.084 in ³
Lubricant outlet connection Outlet thread	6 mm	1/4	6, 8, 10, 12 mm G ^{1/4} or ^{1/4} NPTF	1/4, 3/8 or 1/2
Dimensions	12 outlet basic version: 144 × 135 × 50 mm	5.67 × 5.31 × 1.97 in.	6 outlet basic version: 169 × 132 × 40 mm	6.65 × 5.2 × 1.57 in.

* in compliance with the pressure conditions, see installation instructions

Table 3

Monitoring options	
Visual memory indicators	
Function principle	Magnetic based reset indicator with red fault indicating ring and plastic protection cap
Material	Stainless steel
Operating temperature	–20 to +70 °C –4 to +160 °F
Electrical performance indicators	
Function principle	Electronic piston detector
Material	Stainless steel
Corrosion protection class (DIN EN ISO 12944)	C5-H
Operating temperature	–40 to +85 °C –40 to +185 °F
Design	3 wire DC PNP, 2 wire DC PNP/NPN
Output function	NO-contact
Operating voltage	10–36 DC, supply class 2 according to cULus
Protection class	IP65 / IP68 / IP69K, with cable box screwed on properly
Power consumption	max. 5 mA
Connection	M12x1-4 pole
Standard	CE, UL, CSA, E1

Table 4

Layout variants

Order code	Layout variants				
	A	B	C	D	E
Top	Stroke adjustment	•	•	•	
	Electrical performance detector				•
Bottom	Stroke adjustment			•	•
	Visual memory indicator	•			
	Electrical performance detector		•		

→ page 5 for details

Table 5

Metering volume

Metering fitting Metering screw	Metering volume		Code SLC1 2 outlets/ section twin version	SLC1 1 outlet/ section ¹⁾ single	SLC2 single
	cm ³ /stroke	in ³ /stroke			
•	0,1	0.006	B	–	–
•	0,15	0.009	C	–	–
•	0,2	0.012	D	1	1
•	0,25	0.015	E	–	–
•	0,3	0.018	F	2	2
•	0,4	0.024	G	3	3
•	0,5	0.03	H	4	4
•	0,6	0.036	K	5	5
•	0,7	0.042	L	–	–
•	0,8	0.048	–	6	6
•	1,0	0.06	–	7	7
•	1,2	0.072	–	8	8
•	1,4	0.084	–	9	9
•	– ²⁾	– ²⁾	–	V	V
•	R=0,1–0,7 S=0,2–1,4	0.006–0.042 0.012–0.084	R	S	S
•	– ³⁾	– ³⁾	–	Z	Z
Section not available			X	X	X

¹ Internal crossporting: odd outlet (1, 3, 5, 7, 9, 11) is factory closed; double volume at all even outlets (2, 4, 6, 8, 10, 12)

² Metering screw, reserve, outlet closed*

³ Adjusting screw, reserve, outlet closed*

* Not selectable for SLC1 plug-in type fittings

Table 6

Lubricant inlet connections left/right¹⁾, main line

Tubing Ø mm	Fittings		Joint			Code
	Straight fitting	Banjo fitting	Adjustable elbow	Ferrule and nut	Seal E02	
–	without fitting					X
8	•			•		A
8	•				•	B
8	•					C
10	•			•		D
10	•				•	E
10	•					F
12	•			•		G
12	•				•	H
12	•					I
10		•		•		K
10		•			•	L
12		•		•		M
12		•			•	N
8			•	•		O
8			•		•	P
8			•			R
10			•	•		S
10			•		•	T
10			•			U
12			•	•		V
12			•		•	W
12			•			Y
–	Closure plug					Z

¹ For BSP versions only

Table 7

Lubricant outlet connections, feed line

Tubing Ø mm ¹⁾ in.	Fitting Plug-in type	Joint			Code			
		Ferrule and nut	Seal E02	Without ferrule and nut	SLC1G 6 mm tube	SLC1A 1/4" tube	SLC2G G1/4 BSP	SLC2A 1/4" NPTF
–	without fitting				–	–	X	X
6	•				A	–	A	–
6		•			B	–	B	–
6			•		C	–	C	–
6				•	D	–	D	–
8	•				–	–	E	–
8		•			–	–	F	–
8			•		–	–	G	–
8				•	–	–	H	–
10		•			–	–	I	–
10			•		–	–	K	–
10				•	–	–	L	–
	1/4	•			R	R	–	–
	1/4		•		S	S	–	–

Connections including outlet extensions

6	•				M	–	–	–
6		•			N	–	–	–
6			•		O	–	–	–
6				•	P	–	–	–
	1/4	•			T	T	–	–
	1/4		•		U	U	–	–

¹ For BSP versions only

How to order the SLC components

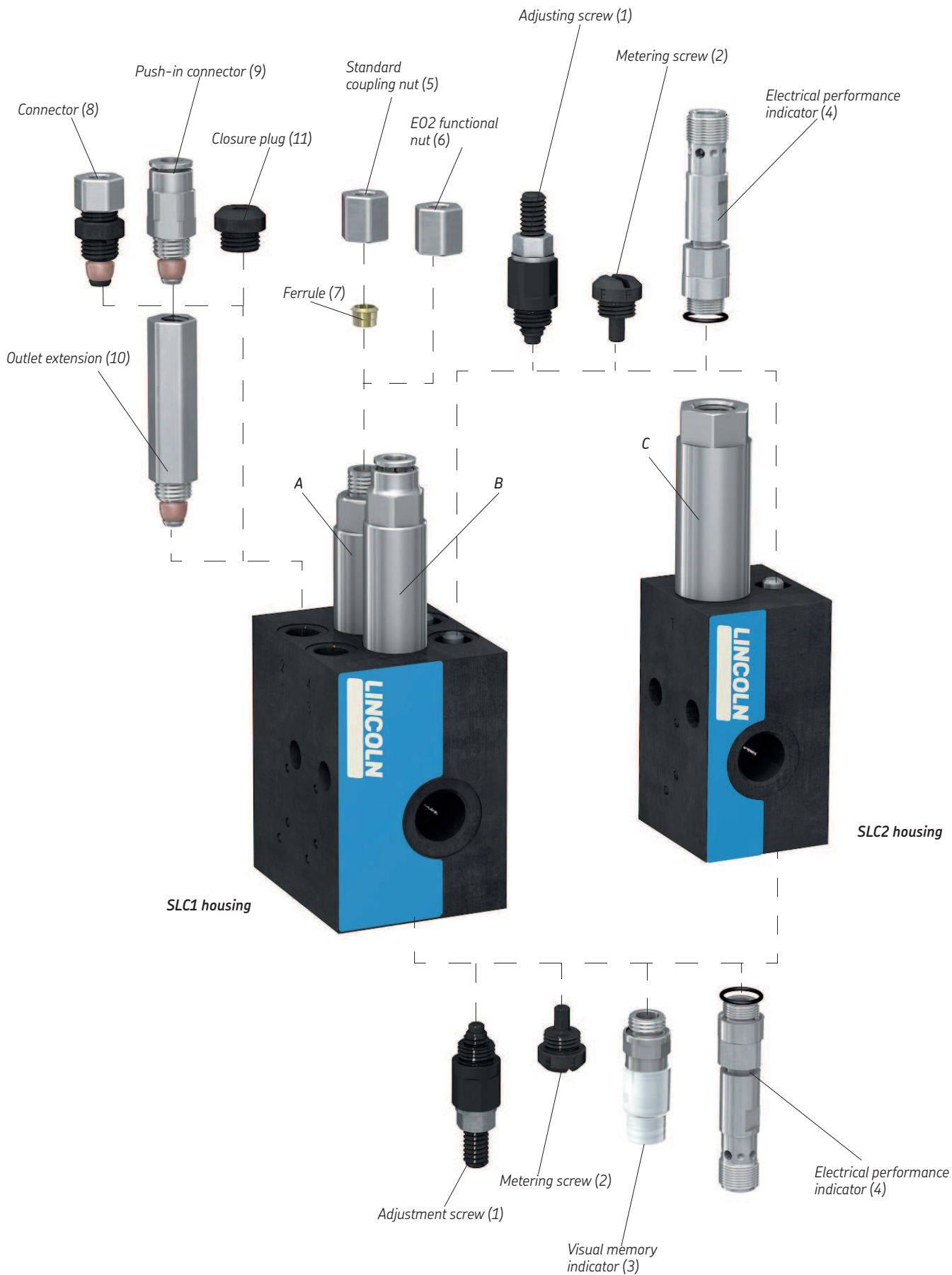

Table 8

Order numbers – Basic metering device¹⁾

→ fig.	Description	Pieces per package	Order number					
			Number of outlets					
SLC1			2	4	6	8	10	12
A	Housing with lubricant inlet G3/8 incl. spring / spring housing suitable for compression fittings Ø6	1	554-85333-1	554-85333-2	554-85333-3	554-85333-4	554-85333-5	554-85333-6
B	Housing with lubricant inlet G3/8 incl. spring / spring housing with push-in fitting for tube Ø6	1	554-85332-4	554-85332-5	554-85332-6	554-85332-7	554-85332-8	554-85332-9
A	Housing with lubricant inlet 3/8 NPTF incl. spring / spring housing suitable for compression fittings Ø1/4	1	554-85331-7	554-85331-8	554-85331-9	554-85332-1	554-85332-2	554-85332-3
B	Housing with lubricant inlet 3/8 NPTF spring / spring housing with push-in fitting for tube Ø1/4	1	554-85331-1	554-85331-2	554-85331-3	554-85331-4	554-85331-5	554-85331-6
SLC2			1	2	3	4	5	6
C	Housing with lubricant inlet G3/8, incl. spring / spring housing outlet G1/4	1	554-85329-7	554-85329-8	554-85329-9	554-85330-1	554-85330-2	554-85330-3
C	Housing with lubricant inlet 3/8 NPTF, incl. spring / spring housing outlet 1/4-18 NPTF	1	554-85329-1	554-85329-2	554-85329-3	554-85329-4	554-85329-5	554-85329-6

¹ All housings are function tested and come without outlet fittings and metering screws

Table 9

Output adjustment options

→ fig.	Description	SLC1 (twin)		SLC1 (single) SLC2		Packing unit	Order number
		cm ³	in ³	cm ³	in ³		
Pieces							
1	Adjusting screw	0,1–0,7	0.006–0.042	0,2–1,4	0.012–0.084	6	554-85325-1
2	Metering screw B	0,1	0.006	0,2	0.012	12	554-85325-2
2	Metering screw C	0,15	0.009	0,3	0.018	12	554-85325-3
2	Metering screw D	0,2	0.012	0,4	0.024	12	554-85325-4
2	Metering screw E	0,25	0.015	0,5	0.03	12	554-85325-5
2	Metering screw F	0,3	0.018	0,6	0.036	12	554-85325-6
2	Metering screw G	0,4	0.024	0,8	0.048	12	554-85325-7
2	Metering screw H	0,5	0.03	1,0	0.06	12	554-85325-8
2	Metering screw K	0,6	0.036	1,2	0.072	12	554-85325-9
2	Metering screw L	0,7	0.042	1,4	0.084	12	554-85326-1
2	Metering screw 2x B–L					18	554-85326-2

Table 10

Monitoring options

→ fig.	Description	Packing unit	Order number
Pieces			
3	Visual memory indicator	6	554-85326-3
4	Electrical performance indicator (piston detector)	1	519-85224-1

Table 11

Outlet connection options SLC1

→ fig.	Description	Packing unit	Order number
Pieces			
For spring housings, even numbered outlets			
5	Coupling nut Ø6-LL	12	554-85326-4
6	Functional nut Ø6-LL-E02	12	554-85326-5
5	Coupling nut Ø1/4 tube	12	554-85326-6
7	Ferrule Ø6-LL	12	554-85326-7
7	Ferrule Ø1/4 tube	12	554-85326-8
For odd numbered outlets			
Adapter with non-return valve assembly			
8	Ø6	12	554-85326-9
8	Ø6-E02	12	554-85327-4
9	Ø6 push-in	12	554-85327-1
8	Ø1/4 tube	12	554-85327-2
9	Ø1/4 push-in	12	554-85327-6
10	Outlet extension M10x1	6	554-85327-5
11	Closure plug M10x1,0x 4,5 / Outlet crossporting	12	554-85327-3

Table 12

Accessories, replacement parts, assembly tools

Description	SLC1	SLC2	Packing unit	Order number
Pieces				
Plug Ø6	•		1	460-706-001
Plug Ø1/4	•		1	432-74192-1
Closure plug G1/4		•	1	223-13702-1
Closure plug 1/4-18 NPTF		•	1	223-11436-1
Closure plug G3/8	•	•	1	223-13702-2
Closure plug 3/8 NPTF	•	•	1	067044
Spring housing for ferrule Ø6	•		1	454-74104-1
Spring housing, assembly Ø6 push-in	•		1	554-60293-1
Spring housing for ferrule Ø1/4	•		1	454-74132-1
Spring housing, assembly Ø1/4 push-in	•		1	554-60321-1
Spring housing, G1/4		•	1	454-74105-1
Spring housing, 1/4-18 NPTF		•	1	454-74133-1
Plastic bag with fixing material M8X70	•		1	554-85328-1
Plastic bag with fixing material M8X65		•	1	554-85328-2
Special screw driver for metering screws	•	•	1	404-22614-1

For more information and all related downloads, see
→ www.skf.com/SLC

Assembly instructions: 951-231-005

CAD models: skf-lubrication.partcommunity.com



skf.com | skf.com/SLC | lincolnindustrial.com

© SKF and Lincoln are registered trademarks of the SKF Group.

© SKF Group 2018

The contents of this publication are the copyright of the publisher and may not be reproduced (even extracts) unless prior written permission is granted. Every care has been taken to ensure the accuracy of the information contained in this publication but no liability can be accepted for any loss or damage whether direct, indirect or consequential arising out of the use of the information contained herein.

PUB LS/P2 17717 EN · March 2018

Certain image(s) used under license from Shutterstock.com.